

---

# 8903/PB Profibus Communications Option

Technical Manual  
HA469267U001 Issue 5

© Copyright 2010 Parker Hannifin Ltd.

All rights strictly reserved. No part of this document may be stored in a retrieval system, or transmitted in any form or by any means to persons not employed by a Parker Hannifin Ltd., Automation Group, SSD Drives Europe without written permission from Parker Hannifin Ltd., Automation Group, SSD Drives Europe. Although every effort has been taken to ensure the accuracy of this document it may be necessary, without notice, to make amendments or correct omissions. Parker Hannifin Ltd., Automation Group, SSD Drives Europe cannot accept responsibility for damage, injury, or expenses resulting there from.

## WARRANTY

Parker Hannifin Ltd., Automation Group, SSD Drives Europe, warrants the goods against defects in design, materials and workmanship for the period of 24 months from the date of manufacture, or 12 months from the date of delivery (whichever is the longer period) on the terms detailed in Parker SSD Drives Standard Conditions of Sale IA500504.

Parker Hannifin Ltd., Automation Group, SSD Drives Europe reserves the right to change the content and product specification without notice.

**FAILURE OR IMPROPER SELECTION OR IMPROPER USE OF THE PRODUCTS DESCRIBED HEREIN OR RELATED ITEMS CAN CAUSE DEATH, PERSONAL INJURY AND PROPERTY DAMAGE.**

This document and other information from Parker-Hannifin Corporation, its subsidiaries and authorized distributors provide product or system options for further investigation by users having technical expertise.

The user, through its own analysis and testing, is solely responsible for making the final selection of the system and components and assuring that all performance, endurance, maintenance, safety and warning requirements of the application are met. The user must analyze all aspects of the application, follow applicable industry standards, and follow the information concerning the product in the current product catalog and in any other materials provided from Parker or its subsidiaries or authorized distributors.

To the extent that Parker or its subsidiaries or authorized distributors provide component or system options based upon data or specifications provided by the user, the user is responsible for determining that such data and specifications are suitable and sufficient for all applications and reasonably foreseeable uses of the components or systems.

# Safety Information



## Requirements

**IMPORTANT:** Please read this information BEFORE installing the equipment.

### Intended Users

This manual is to be made available to all persons who are required to install, configure or service equipment described herein, or any other associated operation.

The information given is intended to highlight safety issues, EMC considerations, and to enable the user to obtain maximum benefit from the equipment.

Complete the following table for future reference detailing how the unit is to be installed and used.

INSTALLATION DETAILS	
<b>Model Number</b> <i>(see product label)</i>	
<b>Where installed</b> <i>(for your own information)</i>	
<b>Unit used as a:</b> <i>(refer to Certification for the Inverter)</i>	<input type="radio"/> Component <input type="radio"/> Relevant Apparatus
<b>Unit fitted:</b>	<input type="radio"/> Wall-mounted <input type="radio"/> Enclosure



### Application Area

The equipment described is intended for industrial motor speed control utilising DC motors, AC induction or AC synchronous machines

### Personnel

Installation, operation and maintenance of the equipment should be carried out by qualified personnel. A qualified person is someone who is technically competent and familiar with all safety information and established safety practices; with the installation process, operation and maintenance of this equipment; and with all the hazards involved.

### Product Warnings

	<b>Caution</b> Risk of electric shock		<b>Caution</b> Refer to documentation		<b>Earth/Ground</b> Protective Conductor Terminal
---	--	---	--	---	--

# Safety Information



## Hazards

### **DANGER! - Ignoring the following may result in injury**

1. This equipment can endanger life by exposure to rotating machinery and high voltages.
2. The equipment must be permanently earthed due to the high earth leakage current, and the drive motor must be connected to an appropriate safety earth.
3. Ensure all incoming supplies are isolated before working on the equipment. Be aware that there may be more than one supply connection to the drive.
4. There may still be dangerous voltages present at power terminals (motor output, supply input phases, DC bus and the brake, where fitted) when the motor is at standstill or is stopped.
5. For measurements use only a meter to IEC 61010 (CAT III or higher). Always begin using the highest range. CAT I and CAT II meters must not be used on this product.
6. Allow at least 5 minutes for the drive's capacitors to discharge to safe voltage levels (<50V). Use the specified meter capable of measuring up to 1000V dc & ac rms to confirm that less than 50V is present between all power terminals and earth.
7. Unless otherwise stated, this product must NOT be dismantled. In the event of a fault the drive must be returned. Refer to "Routine Maintenance and Repair".

### **WARNING! - Ignoring the following may result in injury or damage to equipment**

#### **SAFETY**

Where there is conflict between EMC and Safety requirements, personnel safety shall always take precedence.

- Never perform high voltage resistance checks on the wiring without first disconnecting the drive from the circuit being tested.
- Whilst ensuring ventilation is sufficient, provide guarding and /or additional safety systems to prevent injury or damage to equipment.
- When replacing a drive in an application and before returning to use, it is essential that all user defined parameters for the product's operation are correctly installed.
- All control and signal terminals are SELV, i.e. protected by double insulation. Ensure all external wiring is rated for the highest system voltage.
- Thermal sensors contained within the motor must have at least basic insulation.
- All exposed metalwork in the Inverter is protected by basic insulation and bonded to a safety earth.
- RCDs are not recommended for use with this product but, where their use is mandatory, only Type B RCDs should be used.

#### **EMC**

- In a domestic environment this product may cause radio interference in which case supplementary mitigation measures may be required.
- This equipment contains electrostatic discharge (ESD) sensitive parts. Observe static control precautions when handling, installing and servicing this product.
- This is a product of the restricted sales distribution class according to IEC 61800-3. It is designated as "professional equipment" as defined in EN61000-3-2. Permission of the supply authority shall be obtained before connection to the low voltage supply.

### **CAUTION!**

#### **APPLICATION RISK**

- The specifications, processes and circuitry described herein are for guidance only and may need to be adapted to the user's specific application. We can not guarantee the suitability of the equipment described in this Manual for individual applications.

#### **RISK ASSESSMENT**

Under fault conditions, power loss or unintended operating conditions, the drive may not operate as intended. In particular:

- Stored energy might not discharge to safe levels as quickly as suggested, and can still be present even though the drive appears to be switched off
- The motor's direction of rotation might not be controlled
- The motor speed might not be controlled
- The motor might be energised

A drive is a component within a drive system that may influence its operation or effects under a fault condition. Consideration must be given to:

- Stored energy
- Supply disconnects
- Sequencing logic
- Unintended operation

# Contents

<b>PROFIBUS COMMUNICATIONS OPTION</b>	<b>1</b>
<b>Introduction</b> .....	<b>1</b>
Product Features .....	1
Product Order Code.....	1
Compatible Firmware.....	1
Restrictions.....	1
<b>Installation</b> .....	<b>2</b>
Wiring the System .....	5
• PROFIBUS-DP Cable Specification .....	5
• PROFIBUS-DP Connectors .....	6
• Pin Assignment of the Bus Connector .....	6
• PROFIBUS-DP Network Termination.....	7
• Repeaters .....	7
<b>Setting Node Address</b> .....	<b>8</b>
<b>LED Indications</b> .....	<b>8</b>
Initial Power-on Checks .....	8
<b>Drive Diagnostics</b> .....	<b>9</b>
• The Profibus MMI View .....	9
• Parameter Descriptions .....	9
<b>Configuring the Profibus System</b> .....	<b>10</b>
Step 1: Configuring the Profibus Option using DSE .....	10
• Step 1.1: Inserting a PROFIBUS Function Block.....	10
• Step 1.2: Attaching Fieldbus Connectors .....	11
• Step 1.3: Configuring the Fieldbus Connectors.....	12
• DSE Data Types .....	13
• Profibus PLC Data Types .....	13
• Conversion of DSE Type < > Profibus Type .....	14
• Profibus Status Information.....	14
Step 2: Configuring the PLC/SCADA Supervisor.....	15
The Network Interface .....	18
• PKW (Demand Data) Processing .....	18
• Command.....	18
• Parameter Reference.....	19
• Parameter Value or Error Code .....	19
<b>Appendix A: Troubleshooting</b> .....	<b>20</b>
• 890 Profibus Option Status LED.....	20
<b>Appendix B: DSE/Profibus Conversion Rules</b> .....	<b>21</b>
• LOGIC Type Connector .....	21
• INTEGER Type Connector .....	22
• VALUE Type Connector .....	23



# PROFIBUS COMMUNICATIONS OPTION

## Introduction

This manual describes the Parker SSD Drives' Profibus™ Communications Option.

### Product Features

- Suitable for use with 890CD Common Bus Drive, 890SD Standalone Drive and 890PX Drive
- LEDs to indicate board and communications status
- Hardware/software selectable Node Address
- Up to 256 DSE input registers and 256 DSE output registers

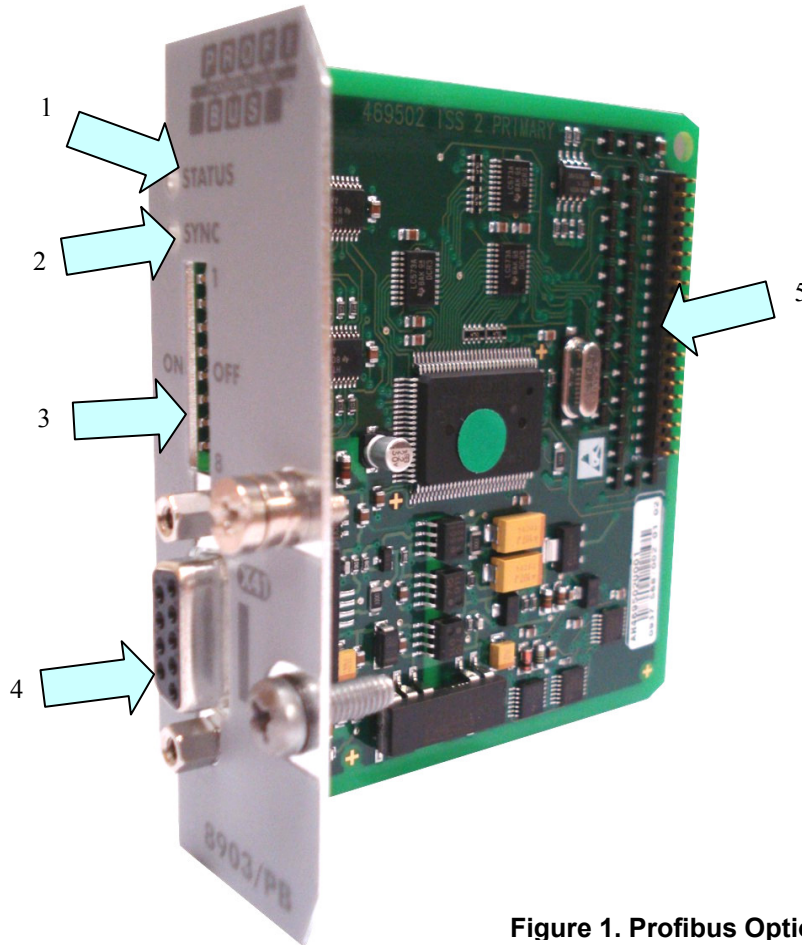

Figure 1. Profibus Option

1	STATUS LED	4	X41 - Profibus Network Connector
2	SYNC LED - for future use	5	Connector to Control Board
3	Node Address		

### Product Order Code

Not fitted order code: 8903-PB-00

Factory fitted order code: 890xx-xxxxxxxx-xxx-xxxPx

### Compatible Firmware

This option will work with the following versions of 890 firmware:

Version 1.4 onwards

Version 2.1 onwards

Version 3.1 onwards

Version 4.1 onwards

### Restrictions

Option must be fitted in Slot A.

# 2

## Installation

### WARNING!

Before installing, ensure that the drive wiring is electrically isolated and cannot be made "live" unintentionally by other personnel. Wait 5 minutes after disconnecting power before working on any part of the system or removing the covers from the drives.

### To Remove the Control Board

1. Remove the blanking plates, each secured by a single screw, that fits over the option slots (1).
2. Loosen the top and bottom screws in the handles of the Control Board (2).
3. Pull gently on the handles and slide the Control Board (2) out of the drive.

**Note:** Save the blanking plate and screw for future use. The drive should not be operated without either an option or a blanking plate fitted. When fitted, these maintain the drive's IP20 rating.

### Caution

This Option contains ESD (Electrostatic Discharge) sensitive parts. Observe static control precautions when handling, installing and servicing this Option.



Figure 2. 890 showing Control Board withdrawn with Options fitted

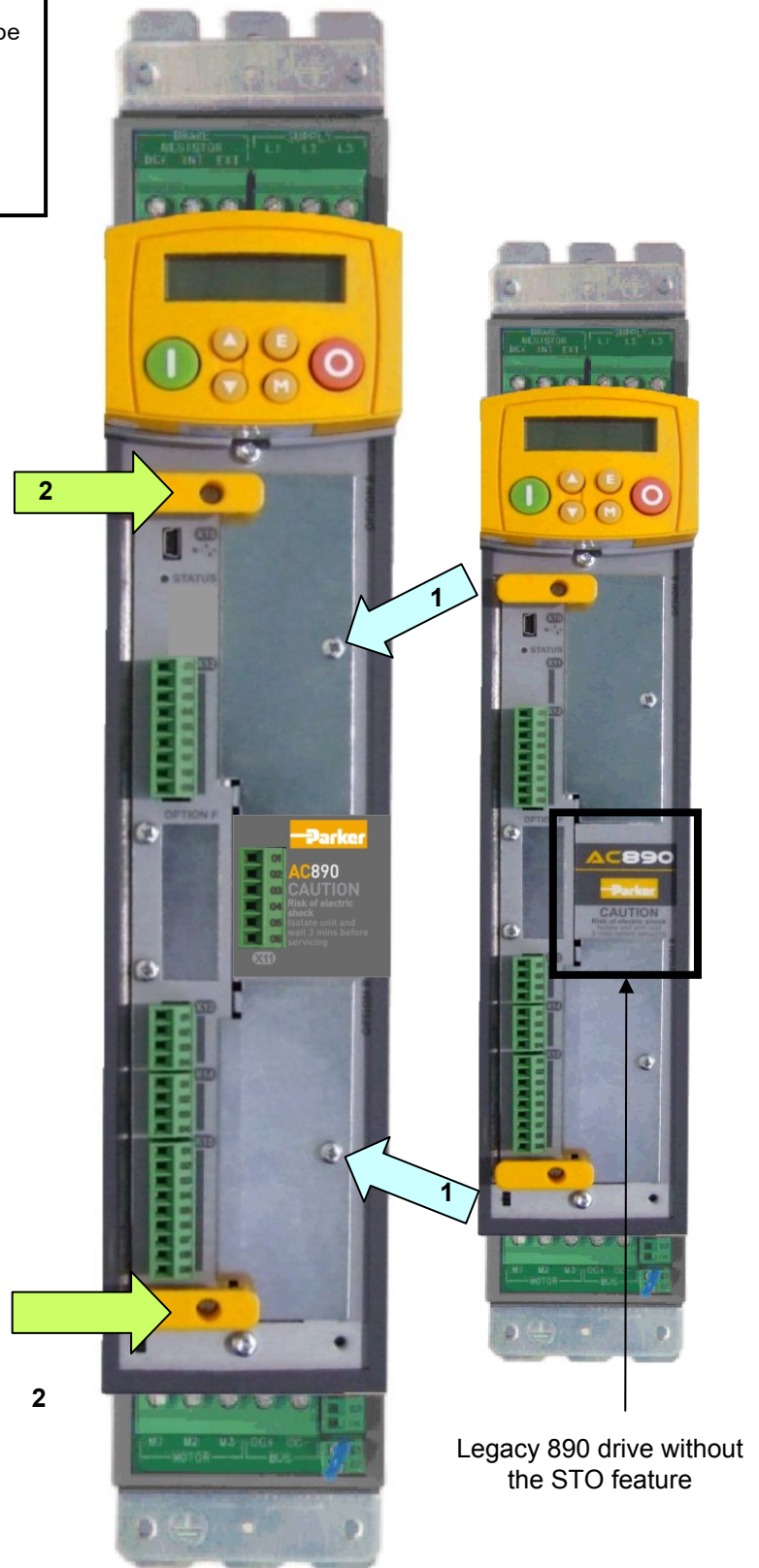

Figure 3. Front of 890 drive showing Control Board fitted



### Fitting the Option

The Option fits onto the Control Board.

1. Insert the connector into the Option as shown. The legs of the connector will protrude through into the connector on the other side of the Option.
2. Press the assembly into the **TOP** connector (adjacent to terminals X10, X11 and X12) on the Control Board. Ensure that the front panel of the Option overlaps the front of the Control Board..

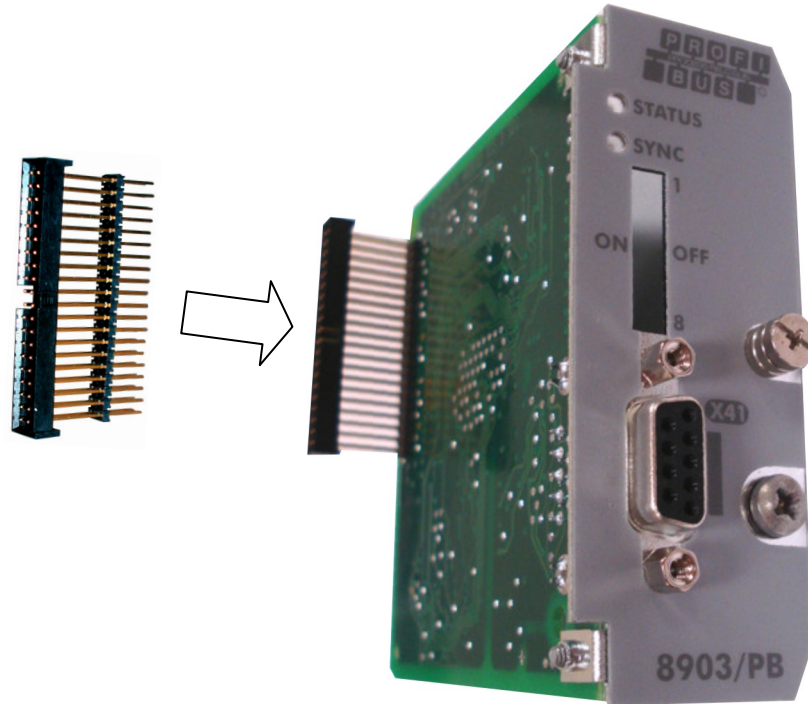

Figure 4. Fitting the connector to the Option

### Re-fitting the Control Board

1. Slide the board into the drive, engaging the edges of the boards into the slots. Push until the back edge of the Control Board PCB locates with the connectors in the drive.
2. Tighten in position using the top and bottom screws in the blue handles of the Control Board.
3. Screw the Option in position using the captive screw on the front of the Option.

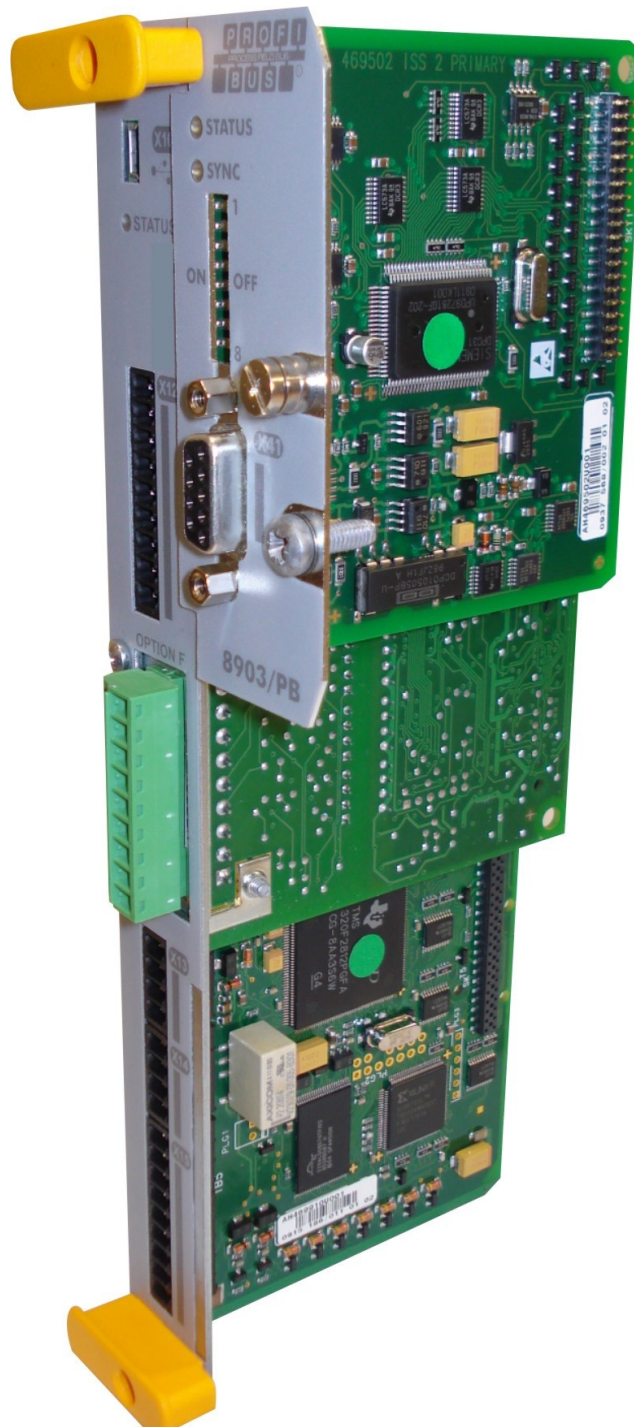

Figure 5. 890 Control Board with Option fitted

## Wiring the System

### WARNING!

Before installing, ensure that the drive and all wiring is electrically isolated and cannot be made "live" unintentionally by other personnel.

Wait 5 minutes after disconnecting power before working on any part of the system or removing the covers from the Drive.

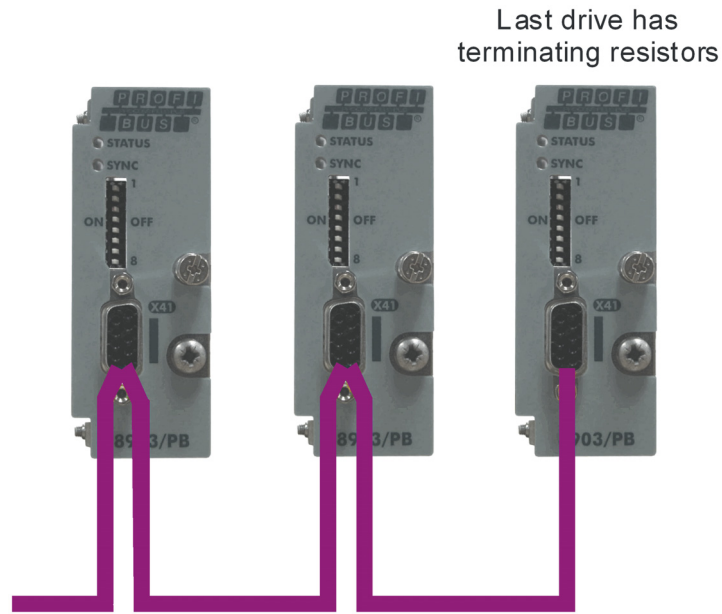

**Note:** It is possible to make serial communications operate without adhering to the following recommendations; however, the recommendations will promote greater reliability.

### PROFIBUS-DP Cable Specification

PROFIBUS-DP cable uses a specific colour code (red/green). You should maintain this colour code throughout your network. The cable has a single twisted pair with overall shielding.

The bus line is specified in IEC 61158 and it can be used in accordance with the table below.

Cable Parameters	PROFIBUS line
Surge impedance in $\Omega$	135 ... 165
Capacitance per unit length (pF/m)	< 30
Loop resistance ( $\Omega$ /km)	110
Core diameter (mm)	0.64
Core cross-section (mm <sup>2</sup> )	> 0.34

**Note:** Belden B3079E cable meets the above specification.

### Maximum Line Length per Bus Segment

Using the specified cable parameters, the maximum line length of a bus segment are as follows:

Transfer rate in kbit/s	9.6	31.25	45.45	93.75	187.5
Cable length	1200	1200	1200	1000	1000
Transfer rate in kbit/s	500	1500	3000	6000	12000
Cable length	400	200	100	100	100

## PROFIBUS-DP Connectors

You should use connectors recommended by Profibus. These connectors will have a shield clamp providing shield continuity and will help to ensure good noise immunity of your network.

We recommend the use of the horizontal Erbic range of PROFIBUS-DP connectors from ERNI:

- ◆ ERNI Part number 103648, grey - used on all nodes in the middle of the network
- ◆ ERNI Part number 103649, yellow - termination connector
- ◆ ERNI Part number 134728, grey - includes switchable termination

For further information, visit [www.erni.com](http://www.erni.com)

## Pin Assignment of the Bus Connector

Pin Number	PROFIBUS-DP Cable	Signal	Meaning
1	Braid	Shield	Shield / protective ground
3	Red (B)	RxD/TxD-P	Receive data / transmission data positive
4		CNTR-P	Control signal for repeater (RTS)
5		DGND	Data transmission potential (ground to 5V) USE ONLY FOR TERMINATION RESISTORS
6		VP	Supply voltage of the terminating resistors- P, (+5V) USE ONLY FOR TERMINATION RESISTORS
8	Green (A)	RxD/TxD-N	Receive data / transmission data negative

## Earthing the Shield

The PROFIBUS standard suggests that both ends of the transmission line should be connected to safety earth. If you do this, ensure that differences in local earth potential do not allow circulating currents to flow, as not only can these induce large common mode signals in the data lines, but they can also produce potentially dangerous heating in the cable. If in doubt, earth the shield at only one section of the network.

## PROFIBUS-DP Network Termination

Failure to terminate a network correctly can reduce the noise immunity of the network and affect performance.

A termination resistor must be fitted at each end of the network to prevent interference.

If too many resistors are fitted to the network, the resulting reduced signal levels may cause nodes to miss bits of information. If network overload becomes excessive, the reduced signal levels may prevent the nodes from detecting any activity.

Connect terminating resistors to the end drives as shown below. (All resistors  $\pm 5\%$ , minimum  $\frac{1}{4}$  Watt).

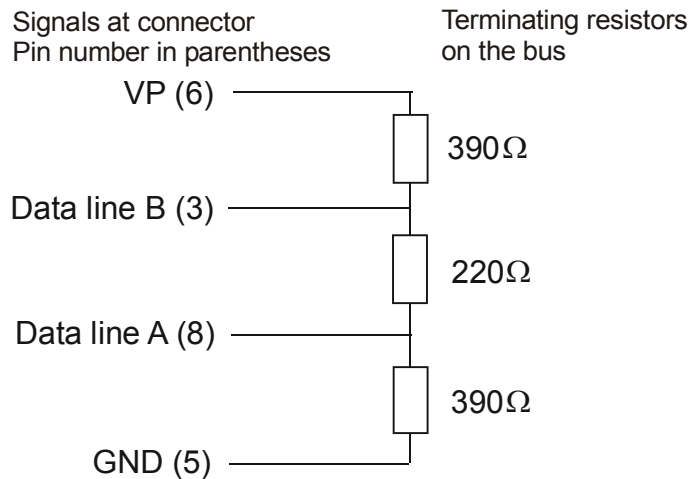

Figure 7. Terminating Resistor Connection

## Repeaters

The maximum number of nodes allowed on a single PROFIBUS-DP network segment is 32. A repeater can be used to extend the network length and/or to allow more than 32 nodes to be connected.

**Note:** *CNTR-P (Pin Number 4) is a TTL level signal that can be connected to a repeater. Most repeaters automatically switch between transmitting and receiving and so do not need this connection.*

# 8

## Setting Node Address

The DIP switches allow you to select 8 bits for the Node Address (NA) (0-255)

*Note: If all 8 bits are in the ON position, the Node Address is set by software.*

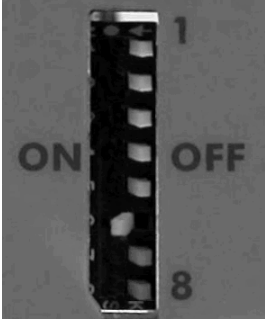
8903/PB Front View	DIP Switch	Value	Function	Example	
	1	1 (2 <sup>0</sup> )	Node Address 0 – 255	0	OFF
	2	2 (2 <sup>1</sup> )		0	OFF
	3	4 (2 <sup>2</sup> )		0	OFF
	4	8 (2 <sup>3</sup> )		0	OFF
	5	16 (2 <sup>4</sup> )		0	OFF
	6	32 (2 <sup>5</sup> )		1	ON
	7	64 (2 <sup>6</sup> )		0	OFF
	8	128 (2 <sup>7</sup> )		0	OFF
				NA = 32	

*Note: Only addresses 1 to 125 are valid Profibus addresses.*

## LED Indications

The STATUS LED indicates the state of the connected network.

The SYNC LED is for future use.

### Initial Power-on Checks

With the correct connections to the active PLC/SCADA supervisor, the STATUS LED will light. Refer to Appendix A: Troubleshooting, page 20 for details of LED indications.

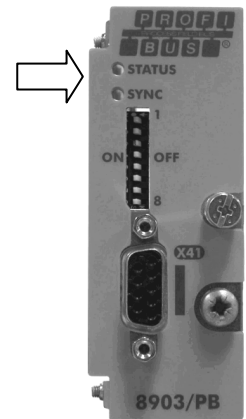

# Drive Diagnostics

---

## The Profibus MMI View

With the Profibus Option correctly installed, the Keypad will display a set of parameters for PROFIBUS.

These are read-only parameters - diagnostics.

## Parameter Descriptions

**BAUDRATE** *Read Only* *Range: Enumerated - see below*

Baudrate of the Profibus network connection set by PLC.

*Enumerated Value : BAUDRATE*

- 0 : 12 Mbits/sec
- 1 : 6 Mbits/sec
- 2 : 3 Mbits/sec
- 3 : 1.5 Mbits/sec
- 4 : 500 kbits/sec
- 5 : 187.5 kbits/sec
- 6 : 93.75 kbits/sec
- 7 : 45.45 kbits/sec
- 8 : 19.2 5 kbits/sec
- 9 : 9.6 kbits/sec
- 10 : UNKNOWN - auto baud not completed

**ADDRESS** *Read Only* *Range: 0 to 125*

The Profibus node address.

If all the DIP switches are set to ON, the Address is set by the DSE configuration.

A specific Address can be set using the DIP switches. Refer to "Setting Node Address", page 8.

If all the DIP switches are set to OFF (i.e. the Address is set to zero) the Profibus option is disabled and does not appear on the Profibus network (see the STATUS parameter below).

**STATUS** *Read Only* *Range: Enumerated - see below*

State of the ControlNet network connection.

*Enumerated Value : STATUS*

- 0 : MISSING OR FAULT
- 1 : DISABLED
- 2 : BAUD SEARCH
- 3 : WAIT PARAM
- 4 : WAIT CONFIG
- 5 : DATA EXCHANGE
- 6 : DATA EXCH NO WD
- 7 : DATA EXCH ERROR
- 8 : DATA EXCH ER NO WD

**ADDRESS METHOD** *Read Only* *Range: Enumerated - see below*

Diagnostic showing the node address setting method. If all of the Address switches on the Profibus Option are set ON, then the method is HARDWARE (switches), otherwise it is SOFTWARE (DSE).

*Enumerated Value : ADDRESS METHOD*

- 0 : SOFTWARE
- 1 : HARDWARE

## Configuring the Profibus System

To configure the Profibus system, complete the steps below. Our example is shown using a PLC configured using Siemens STEP7. For other systems, refer to the manufacturer's instructions.

### Step 1: Configuring the Profibus Option using DSE

You can configure your Profibus Option using DSE.

Follow the instructions below.

#### Step 1.1: Inserting a PROFIBUS Function Block

Display your configuration page. Click on the Block menu at the top of the screen.

1. Move the cursor down to select "890 Comms" and select "Profibus".
2. Click to select the Profibus block. Move this to where you want on the screen then click again to place the block.

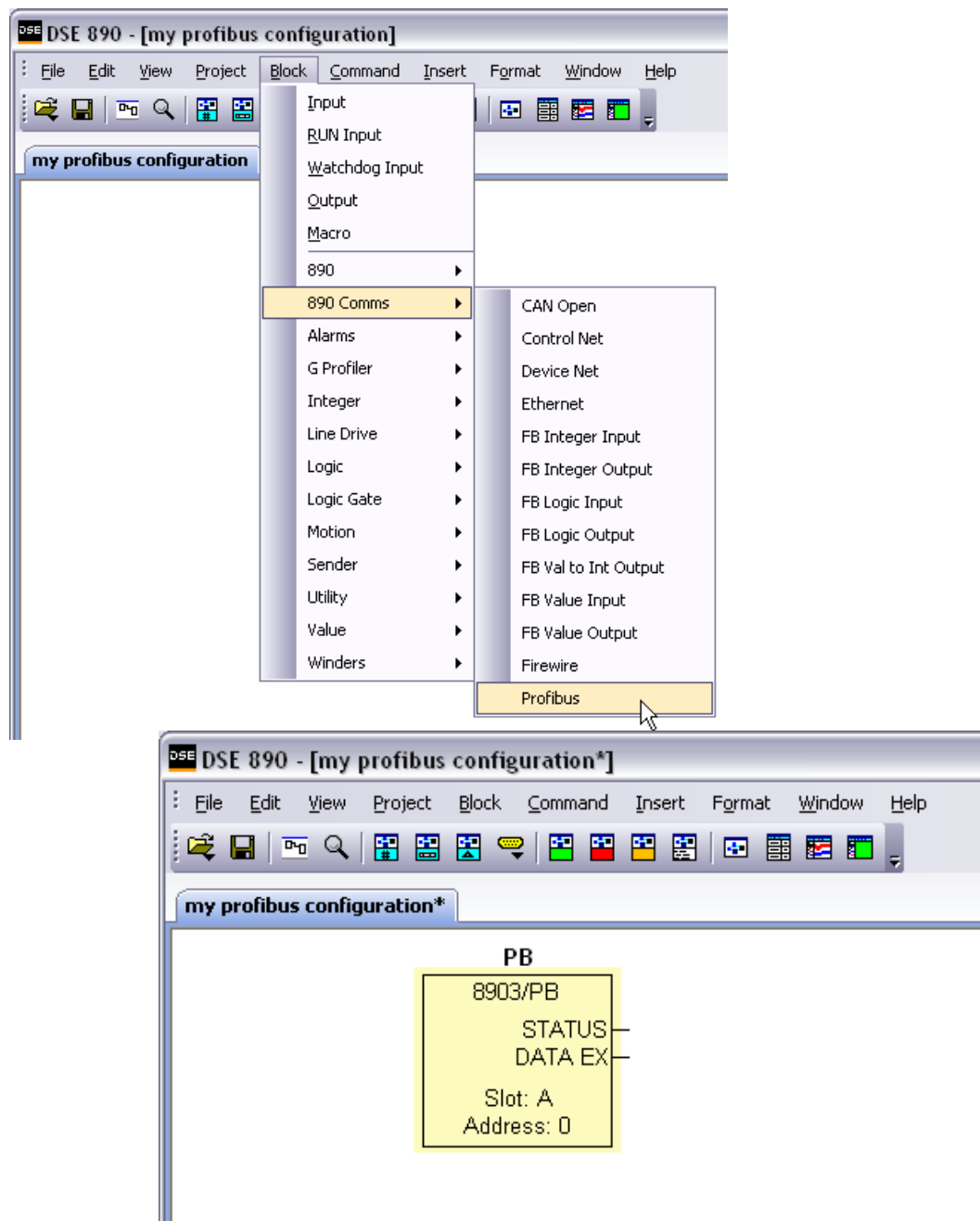

Figure 8. Configuration showing PB function block



## Step 1.2: Attaching Fieldbus Connectors

Seven fieldbus connector types are available:

FB Integer Input      FB Logic Input      FB Value Input  
 FB Integer Output    FB Logic Output    FB Value Output    FB Val to Int Output

**Input connector:** the data is sent from PLC → 890

**Output connector:** the data is sent from 890 → PLC

The fieldbus connectors must be added before they will appear in the Profibus function block.

*Note:* The function block and connectors can be renamed by using the right mouse button and selecting **Rename Block**.

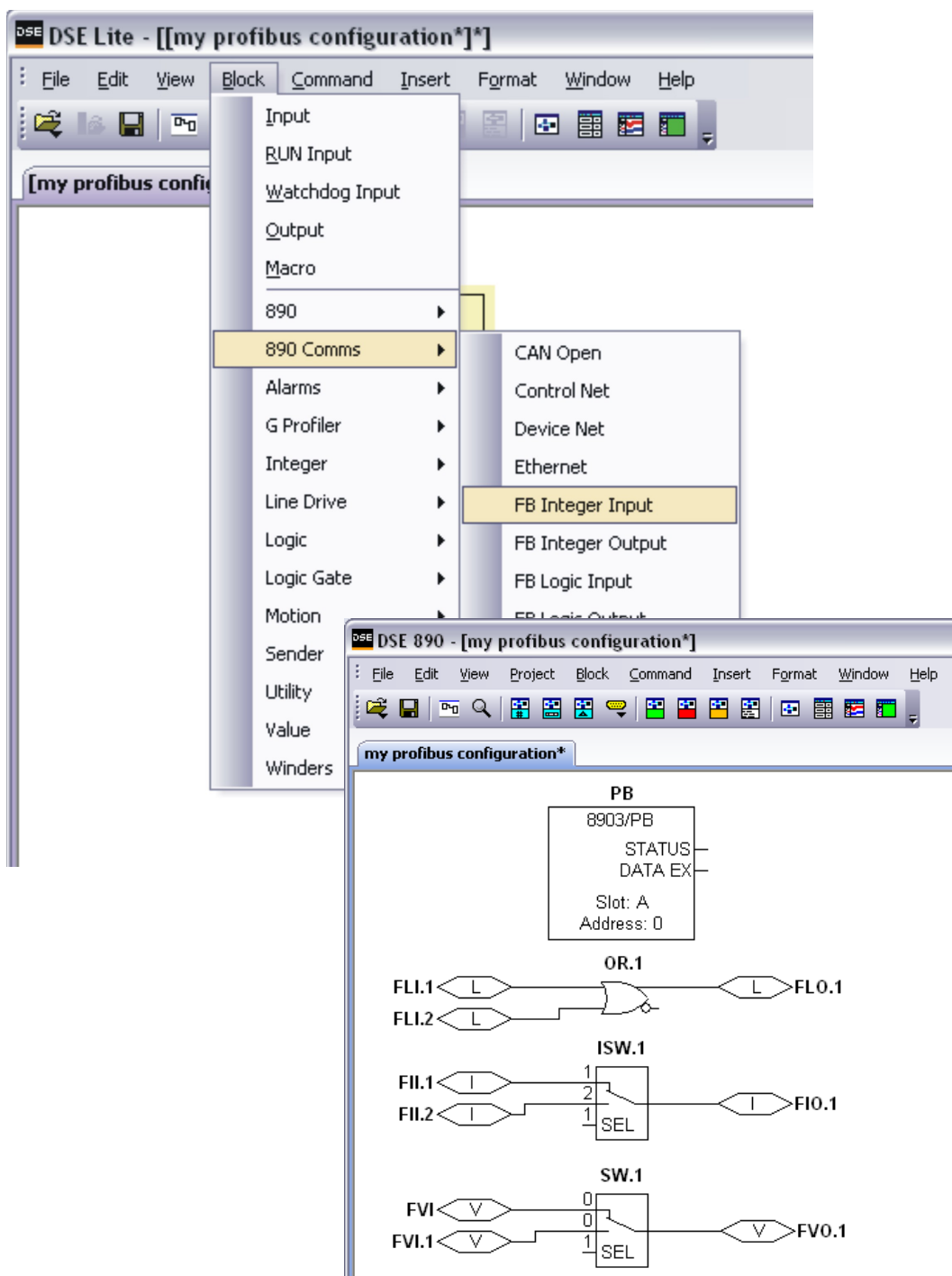
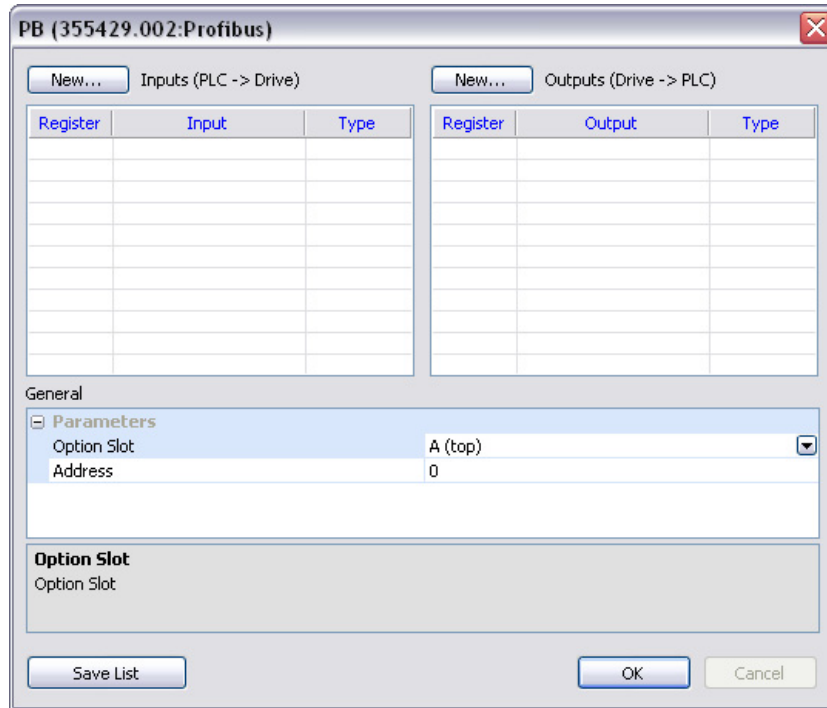

Figure 9. Configuration showing PB function block and Fieldbus Connectors

### Step 1.3: Configuring the Fieldbus Connectors

Double-click on the function block to display the dialog below. The fieldbus connectors (inputs and outputs) are assignable in the function block along with their data type to/from the PLC. The option slot and Address can also be selected.



To configure the input and output connectors you have placed in the configuration:

1. Click on **New...** to add Inputs or Outputs to table.
2. Select the drop-down menu below **Input** to choose the required input connector to be mapped to the Register. For example below, Register 1 "Input" is shown with the possible fieldbus selections that have been placed in the configuration: FII.1 (Fieldbus Integer Input 1), FLI.1 (Fieldbus Logic Input 1), FVI.1 (Fieldbus Value Input 1) etc.

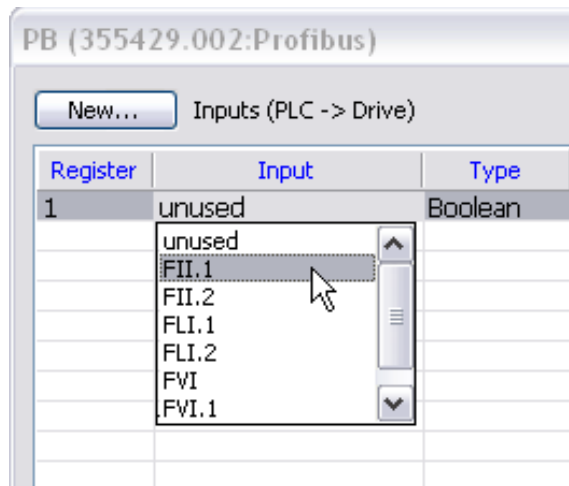
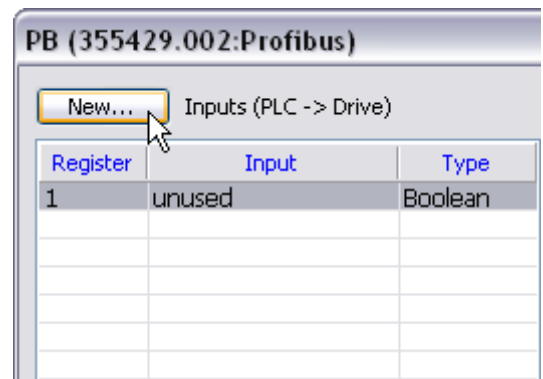

3. Select the drop down menu below **Type** to choose the required PLC type on Register 1, for example.

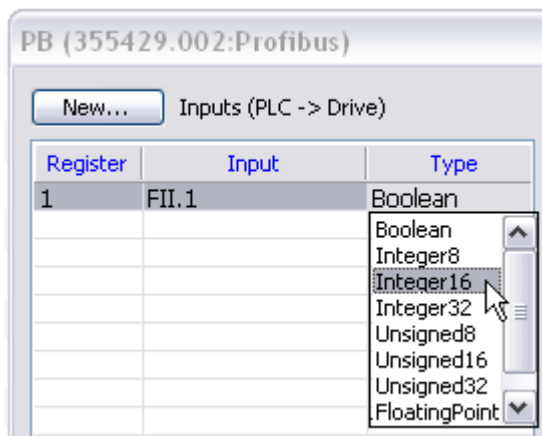

4. Set up all the input/output registers in a similar way.
5. The Address can be selected in the range 0 – 125. This can be confirmed by the ADDRESS diagnostic on the Keypad.

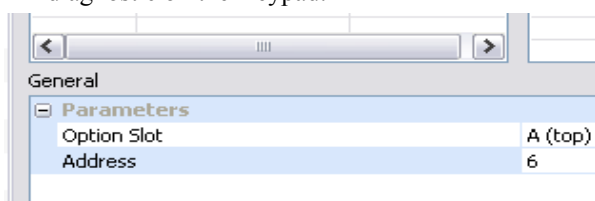

**MMI Menu Map**

1	SETUP
2	COMMUNICATIONS
3	PROFIBUS
	BAUDRATE
	ADDRESS
	STATUS
	ADDRESS METHOD

**Note:** The Address set in DSE will only be used if the Address switches on the Profibus Option are set to ON. If the Address is set to zero and the switches on the Profibus Option are all set to ON, the option is disabled and will not appear on the Profibus network.

6. "Option Slot" = A (top). The Profibus Option can only be fitted in the OPTION A slot on the front of the drive. This is the default setting for "Option Slot".

## DSE Data Types

Data Type	Description	Range
LOGIC	Logic	False (F) and True (T)
INTEGER	32-bit signed integer	-2,147,483,648 to 2,147,483,647
VALUE	32-bit fixed point value	-32768.0 to 32767.9999

## Profibus PLC Data Types

Data Type	Description	Range	PLC Size
Boolean	8-bit Boolean	False (0x00) and True (0x01)	byte
Integer8	8-bit signed integer	-128 to 127	byte
Integer16	16-bit signed integer	-32,768 to 32,767	word
Integer32	32-bit signed integer	-2,147,438,648 to 2,147,483,647	dword
Unsigned8	8-bit unsigned integer	0 to 255	byte
Unsigned16	16-bit unsigned integer	0 to 65,535	word
Unsigned32	32-bit unsigned integer	0 to 4,294,967,295	dword
FloatingPoint	32-bit IEEE-754 floating-point value	1.19209290e-38 to 3.4028235e+38	dword

## Conversion of DSE Type < > Profibus Type

The DSE fieldbus connectors are each assigned a Profibus PLC "Type" as described in "Step 1.3: Configuring the Fieldbus Connectors" on page 12.

The conversion between the DSE type and the PLC type is performed automatically (refer to Appendix B: DSE/Profibus Conversion Rules, page 21).

Any PLC type can be assigned to a fieldbus connector

Some recommended PLC type assignments to fieldbus connectors are given in the table below:

Fieldbus Connector	PLC Type	PLC Size
LOGIC	Boolean	byte
INTEGER	Integer32	dword
VALUE	FloatingPoint	dword

## Profibus Status Information

The Profibus function block in DSE provides status information about the Profibus network interface.

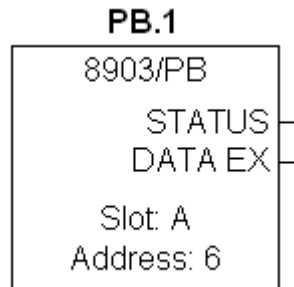

When online, the *actual* Address in use can be found by clicking the right mouse button over the "Address:" text and selecting **Get**. This may be different to the Address set in the function block configuration if the switches on the Option have set the Address.

The function block also provides two status outputs that can be wired to: STATUS and DATA EX.

For example, the DATA EX output could be ANDed with the motor START causing the drive to stop if the PLC connection is lost.

### STATUS

Enumerated value: Status

- 0: MISSING OR FAULT
- 1: DISABLED
- 2: BAUD SEARCH
- 3: WAIT PARAM
- 4: WAIT CONFIG
- 5: DATA EXCHANGE
- 6: DATA EXCH NO WD
- 7: DATA EXCH ERROR
- 8: DATA EXCH ER NO WD

### DATA EX

Logic value: True (T) indicates that the Profibus interface is in the Data Exchange state.

The STATUS output could be used with the LOGIC::LOOKUP function block to determine a particular state.

## Step 2: Configuring the PLC/SCADA Supervisor

*Note:* This example uses the Siemens Simatic 7 PROFIBUS configuration tool, Siemens STEP 7 Simatic manager.

1. Create a project selecting the PLC hardware to be used. Click on Hardware...

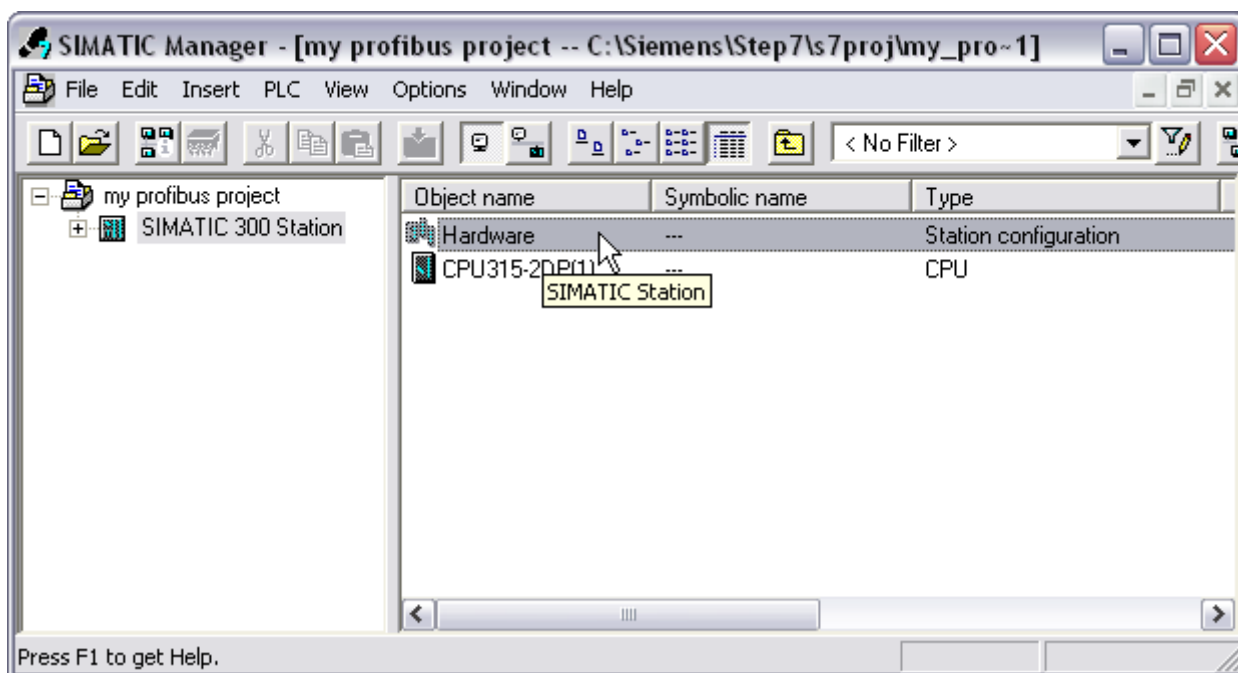

2. Import the GSD file for the 890 so that it appears in the Hardware Catalog. Click on **Options...Install New GSD...**, then use the file explorer to select the file **ssd4890.gsd**

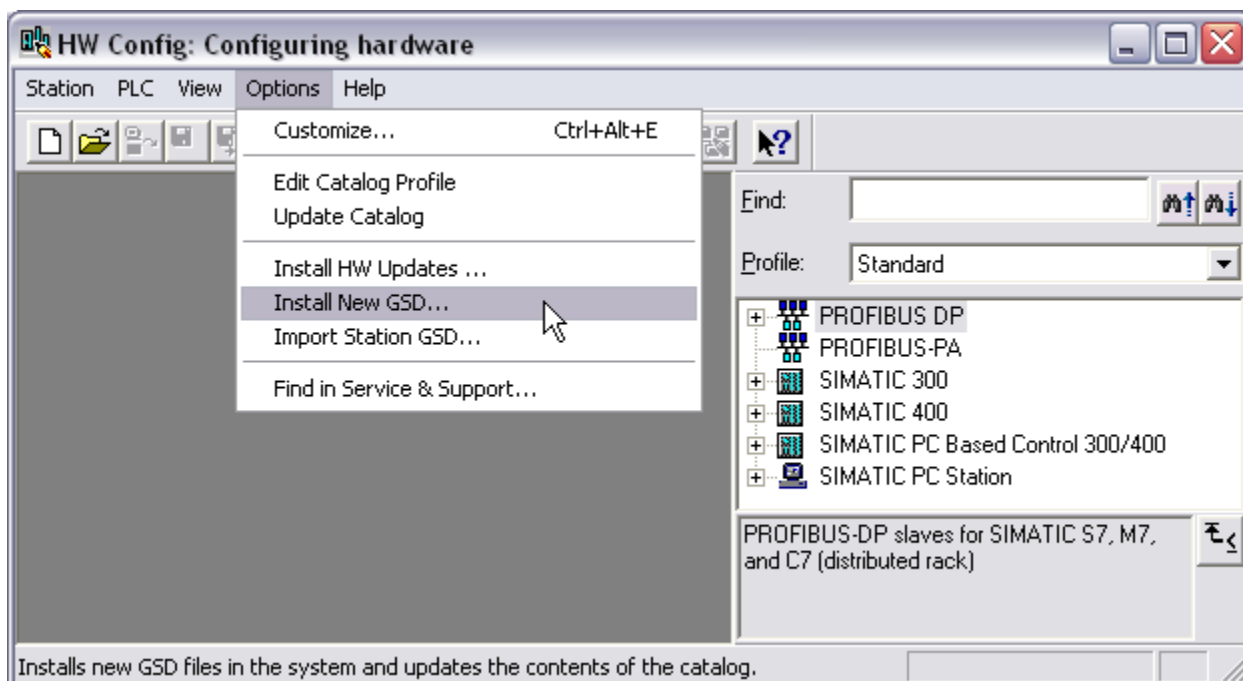

3. Open the project for the Profibus Master. Find the Device Description for the **SSD Drives 890** which can be found under **PROFIBUS DP:Additional Field Devices: Drives:SSD Drives** in the Hardware Catalog window. Select with the mouse and drag

across to the DP Master in the station window.. The required node address for the 890 must be entered when prompted.

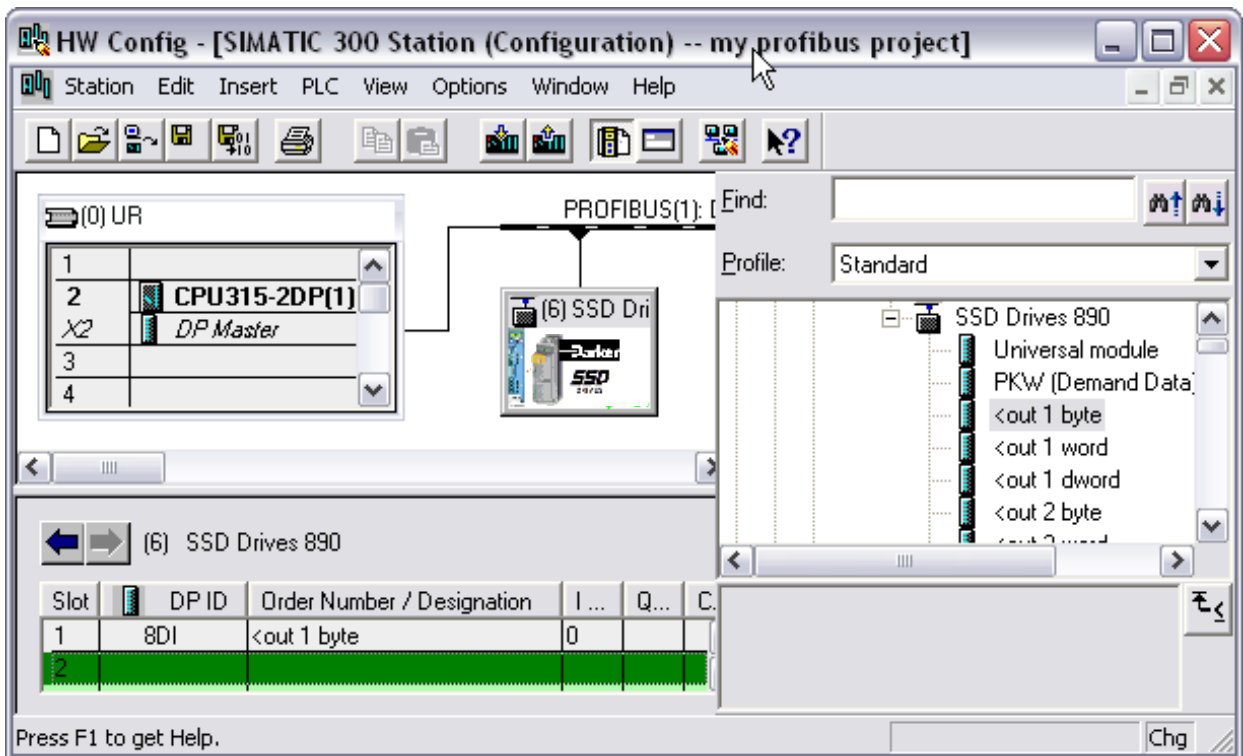

4. Configure which 890 registers are to be exchanged with the Master. These are picked from the 890 in the Hardware Catalog window. First click on the 890 icon in the Station window to open the register list for this node in the lower Station window. Select the required module in the Hardware Catalog window and then click or drag to the lower Station window.

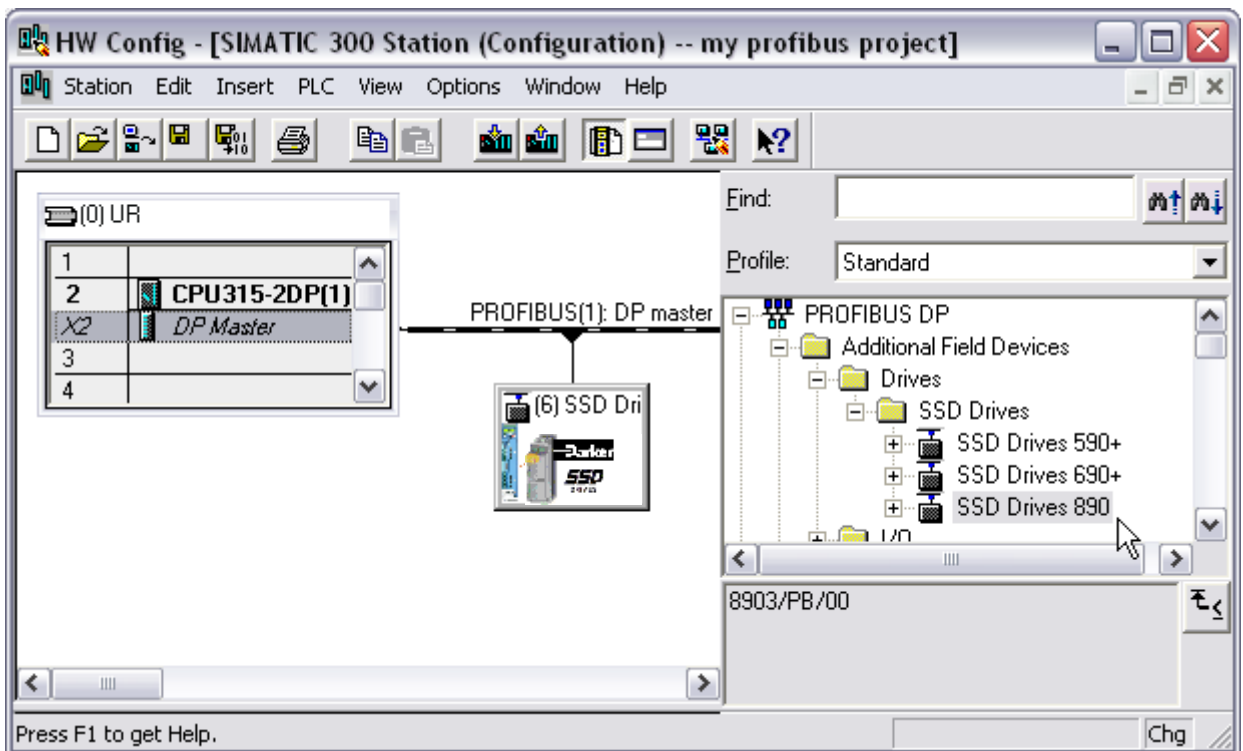

Three types of module can be selected:

**1 : PKW (Demand data)**

This is to enable cyclic data transfer via the PKW mechanism as defined by PROFIDRIVE V0.

Refer to page 18.

*Note: If this feature is required, it must be the first module declared.*

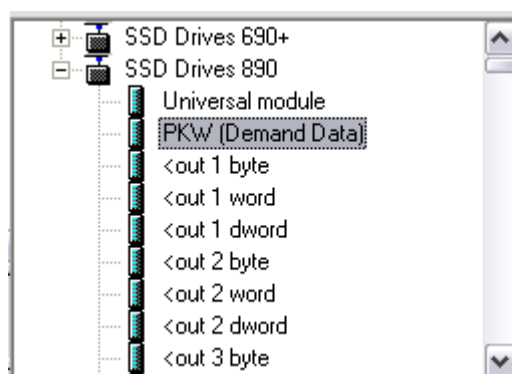

**2 : User defined Input and Output Registers**

These are the registers as declared in the DSE configuration. Each register is declared as being either byte (Boolean, Integer8, Unsigned8), word (Integer16, Unsigned16) or dword (Integer32, Unsigned32, FloatingPoint). The matching module must be selected.

For example, if Input Register 1 (PLC -> Drive) is declared as a Boolean in DSE, then the ">in 1 byte" module must be selected.

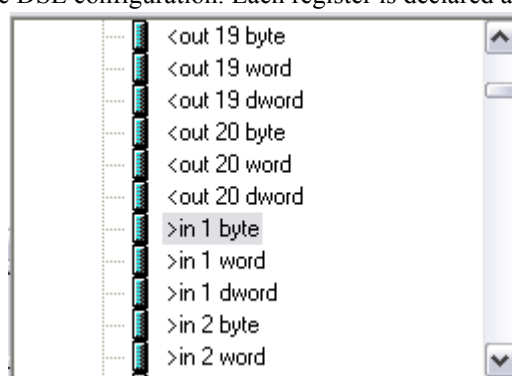

**3 : Fixed Parameters**

These are Drive parameters that are always present in the 890. They can be found in the Motor Control macro block in DSE Configuration Tool.

For example, selecting the ">95.5 comms control:comms command" module adds the COMMS COMMAND parameter, which has reference 95.5, to the Output Data from the PLC.

*Note: For fixed parameters, no configuration is required in the 890. Each parameter has a fixed size / encoding as described in the DSE Configuration Tool.*

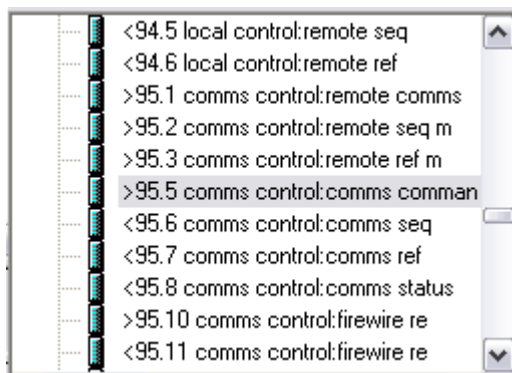

A combination of the above module types may be included, for example:

Slot	DP ID	Order Number / Designation	I ...	Q...	Comment
1	115	PKW (Demand Data)	256...	256...	
2	8D0	>in 1 byte		0	
3	225	>in 2 dword		264...	
4	1A0	>95.5 comms control:comms cor		268...	
5	1AI	<out 1 word	264...		
6	1AI	<95.8 comms control:comms stal	266...		
7					
8					

## The Network Interface

### PKW (Demand Data) Processing

PKW is a sub-protocol using the first 8 bytes (octets) in both the request and response message of the cyclic Data Exchange. It allows random read/write access to any parameter within the Drive. It is enabled by the Profibus-DP- Master setting the first byte of the Cfg\_Data to 0x73. A PKW module is contained in the GSD file installed when configuring the PLC/SCADA Supervisor.

The sub-protocol consists of 3 parts:

- **Command**
- **Parameter Reference**
- **Parameter Value or Error Code**

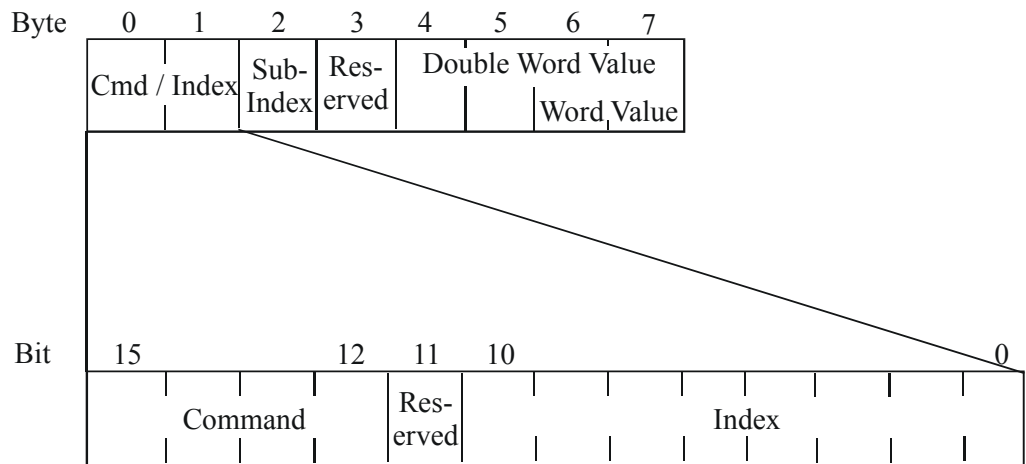

### Command

The Command field in the request message selects the required operation. This is either None, Read, Write Word, or Write Double Word.

The Command field in the response message either confirms that no operation has been requested, indicates that a Read or Write request has been completed successfully or indicates that a Read or Write request has failed.

Valid values for the Command field are:

Command	Request (Master to Slave)	Positive Response (Slave to Master)
0	No Command	0
1	Read Request	1 or 2
2	Write Word Request	1
3	Write Double Word Request	2
6	Read Request (array)	4 or 5
7	Write Word Request (array)	4
8	Write Double Word Request	5



The valid Response Codes are:

Response	Meaning
0	No Response
1	Transfer Word
2	Transfer Double Word
4	Transfer Word (array)
5	Transfer Double Word (array)
7	Request Rejected with error code

## Parameter Reference

The Parameter Reference consists of an Index and a Sub-Index:

- ◆ For User Defined Input Registers, the Index is 254 and the Sub-Index is the Input Register Number
- ◆ For User Defined Output Registers, the Index is 255 and the Sub-Index is the Output Register Number
- ◆ For Fixed Parameters, the Index is the "Block" number and the Sub-Index is the "Parameter" number. These are listed in the GSD file, in the DSE Configuration Tool, or can be displayed on the MMI by holding the "M" key for a few seconds whilst displaying the parameter (PREF).

## Parameter Value or Error Code

The Value/Error Code field is used to receive a Read value, send a Write value or receive an error code.

The Value is either a Word (16-bit) or a Double Word (32-bit):

- ◆ If a Word, the value is transferred in octets 6 and 7 of the request and/or response
- ◆ If a Double Word, the value is transferred in octets 4, 5, 6 and 7.









If the Response Command is 7, i.e. the request has been rejected, this field contains the error code. These are:

Error Code	Meaning
0	Invalid Tag Number
1	Read Only Parameter
2	Value Under/Over-Range
3	Incorrect Data Type
17	Request cannot be processed because of operating state
18	Other error

## Appendix A: Troubleshooting

### 890 Profibus Option Status LED

**Table 1**

Colour	LED Indication	Description
 OFF	OFF	Drive is not powered or fault
 RED	ON	Drive is not initialised or fault
 RED/OFF	75% RED	Disabled. The Node Address has been set to zero.
 RED/OFF	50% RED	Baud Search. PLC not connected or halted.
 RED/OFF	25% RED	Waiting Parameterisation or waiting Configuration. Either the 890 is not being addressed by the PLC or the 890 is rejecting the Parameterisation or Configuration.
 GREEN/OFF	75% GREEN	Data Exchange with watchdog (response monitoring) enabled. No errors.
 GREEN/OFF	50% GREEN	Data Exchange with watchdog (response monitoring) disabled.
 RED/GREEN	25% RED 75% GREEN	Data Exchange with watchdog (response monitoring) enabled. Errors detected, e.g. values from PLC out-of-range.
 RED/GREEN	50% RED 50% GREEN	Data Exchange with watchdog (response monitoring) disabled. Errors detected, e.g. values from PLC out-of-range.

**Table 2**

NETWORK STATES		
0	MISSING OR FAULT	No power, not fitted or fault
1	DISABLED	Option disabled. Address set to 0
2	BAUD SEARCH	Baud search. Waiting for communications on Profibus. To allow auto baud.
3	WAIT PARAM	Waiting for valid parameterisation message to be sent to this node.
4	WAIT CONFIG	Waiting for valid parameterisation message to be sent to this node.
5	DATA EXCHANGE	Data Exchanging with watchdog (response monitoring) enabled
6	DATA EXCH NO WD	Data Exchanging with watchdog (response monitoring) disabled
7	DATA EXCH ERROR	Data Exchanging with watchdog (response monitoring) enabled with errors.
8	DATA EX ER NO WD	Data Exchanging with watchdog (response monitoring) disabled with errors.

## Appendix B: DSE/Profibus Conversion Rules

The rules governing the conversion between 890 data types and Profibus PLC data types are given below. Note carefully that some conversions will result in rounding, limiting and truncation of the original value.

### LOGIC Type Connector

	Data from PLC	Data to 890
<b>From BOOLEAN to LOGIC</b>	False	False
	True	True
<b>From FLOATING POINT to LOGIC</b>	Zero	False
	Non-zero	True
<b>From INTEGER 8 to LOGIC</b>	Zero	False
	Non-zero	True
<b>From INTEGER 16 to LOGIC</b>	Zero	False
	Non-zero	True
<b>From INTEGER 32 to LOGIC</b>	Zero	False
	Non-zero	True
<b>From UNSIGNED 8 to LOGIC</b>	Zero	False
	Non-zero	True
<b>From UNSIGNED 16 to LOGIC</b>	Zero	False
	Non-zero	True
<b>From UNSIGNED 32 to LOGIC</b>	Zero	False
	Non-zero	True

	Data from 890	Data to PLC
<b>From LOGIC to BOOLEAN</b>	False	False
	True	True
<b>From LOGIC to FLOATING POINT</b>	False	0.0
	True	1.0
<b>From LOGIC to INTEGER 8</b>	False	0
	True	1
<b>From LOGIC to INTEGER 16</b>	False	0
	True	1
<b>From LOGIC to INTEGER 32</b>	False	0
	True	1
<b>From LOGIC to UNSIGNED 8</b>	False	0
	True	1
<b>From LOGIC to UNSIGNED 16</b>	False	0
	True	1
<b>From LOGIC to UNSIGNED 32</b>	False	0
	True	1

**INTEGER Type Connector**

	<b>Data from PLC</b>	<b>Data to 890</b>
<b>From BOOLEAN to INTEGER</b>	False True	0x0000 0000 0x0000 0001
<b>From INTEGER 8 to INTEGER</b>	-128 to 127	-128 to 127
<b>From INTEGER 16 to INTEGER</b>	-32,768 to 32,767	-32,768 to 32,767
<b>From INTEGER 32 to INTEGER</b>	-2,147,483,648 to 2,147,483,547	-2,147,483,648 to 2,147,483,547
<b>From UNSIGNED 8 to INTEGER</b>	0 to 255	0 to 255
<b>From UNSIGNED 16 to INTEGER</b>	0 to 65,535	0 to 65,535
<b>From UNSIGNED 32 to INTEGER</b>	0 to 4,294,967,295	0 to 2,147,483,647 limits apply
<b>From FLOATING POINT to INTEGER</b>	32-bit IEEE floating- point	-2,147,483,648 to 2,147,483,547 Fractional part rounded

	<b>Data from 890</b>	<b>Data to PLC</b>
<b>From INTEGER to BOOLEAN</b>	Zero Non-zero	True False
<b>From INTEGER to FLOATING POINT</b>	-2,147,483,648 to 2,147,483,647	32-bit IEEE floating- point
<b>From INTEGER to INTEGER 8</b>	-2,147,483,648 to 2,147,483,647	-128 to 127 limits apply
<b>From INTEGER to INTEGER 16</b>	-2,147,483,648 to 2,147,483,647	-32768 to 32767 limits apply
<b>From INTEGER to INTEGER 32</b>	-2,147,483,648 to 2,147,483,647	-2,147,483,648 to 2,147,483,647
<b>From INTEGER to UNSIGNED 8</b>	-2,147,483,648 to 2,147,483,647	0 to 255 limits apply
<b>From INTEGER to UNSIGNED 16</b>	-2,147,483,648 to 2,147,483,647	0 to 65,535 limits apply
<b>From INTEGER to UNSIGNED 32</b>	-2,147,483,648 to 2,147,483,647	0 to 2,147,483,647 limits apply

## VALUE Type Connector

	Data from PLC	Data to 890
<b>From BOOLEAN to VALUE</b>	False True	0.0 1.0
<b>From FLOATING POINT to VALUE</b>	32-bit IEEE floating-point	-32,768.0 to 32,767.9999
<b>From INTEGER 8 to VALUE</b>	-128 to 127	-128.0 to 127.0
<b>From INTEGER 16 to VALUE</b>	-32,768 to 32,767	-32,768.0 to 32,767.0
<b>From INTEGER 32 to VALUE</b>	-2,147,483,648 to 2,147,483,547	-32,768.0 to 32,767.0 limits apply
<b>From UNSIGNED 8 to VALUE</b>	0 to 255	0.0 to 255.0
<b>From UNSIGNED 16 to VALUE</b>	0 to 65,535	0.0 to 32,767.0 limits apply
<b>From UNSIGNED 32 to VALUE</b>	0 to 4,294,967,295	0.0 to 32,767.0 limits apply

	Data from 890	Data to PLC
<b>From VALUE to BOOLEAN</b>	Zero Non-zero	False True
<b>From VALUE to FLOATING POINT</b>	-32,768.0 to 32,767.9999	32-bit IEEE floating-point
<b>From VALUE to INTEGER 8</b>	-32,768.0 to 32,767.9999	-128 to 127 limits apply/ rounding applies
<b>From VALUE to INTEGER 16</b>	-32,768.0 to 32,767.9999	-32,768 to 32,767 limits apply/ rounding applies
<b>From VALUE to INTEGER 32</b>	-32,768.0 to 32,767.9999	-32,768 to 32,767 limits apply/ rounding applies
<b>From VALUE to UNSIGNED 8</b>	-32,768.0 to 32,767.9999	0 to 255 limits apply/ rounding applies
<b>From VALUE to UNSIGNED 16</b>	-32,768.0 to 32,767.9999	0 to 32,767 limits apply/ rounding applies
<b>From VALUE to UNSIGNED 32</b>	-32,768.0 to 32,767.9999	0 to 32,767 limits apply/ rounding applies

ISS.	MODIFICATION	ECN No.	DATE	DRAWN	CHK'D
1	Initial Issue (HA469267U001)	17320	03/06/05	CM	KJ
2	Various small amendments	19213	15/02/06	CM	KJ
3	Company name change.	19591	26/04/07	CM	KJ
4	New Warranty details New Safety Information	20358 (20280)	06/01/09	CM	KJ
5	DSE screen shots brought up-to-date Page 11 Replaced six with seven and added FB Val to Int Output. Replaced techcard with Option and Replaced DSE 890 with DSE. Other minor corrections and amendments.	20814	12 Feb 09	FEP	MF
FIRST USED ON		MODIFICATION RECORD 8903/PB Profibus Communications Interface			
		DRAWING NUMBER  ZZ469267C001			SHT. 1  OF 1



